

From the house of



quick, affordable
& durable construction

Vboard

Technical handbook

Vboard

Vboard, a Non Asbestos Fiber Cement Board, manufactured by Visaka Industries Ltd. offers unmatched quality, aesthetics, style and durability. An ideal choice for smart, good looking interiors and exterior applications, **Vboard** is fire, water and termite resistant and has the functional efficiency and workability as Timber / Plywood.

The production facilities are located at Miryalguda in Andhra Pradesh, and Daund, Near Pune, Maharashtra, India exclusively meant for the production of non-asbestos fiber cement board known as **Vboard**. The **Vboard** is made with world-class technology as its backbone. Superior grade cellulose fibers and inorganic binders of siliceous base are used in the making of **Vboard**. The matrix once prepared is cured at high pressure and high temperature in autoclaves to achieve strength.



The Vboard Advantage

- ✓ Green Building Product hence energy saver
- ✓ Low thermal conductivity value results in good insulation properties
- ✓ Termite and fungus resistant
- ✓ Water resistant
- ✓ Fire resistant
- ✓ Excellent workability
- ✓ Dimensionally stable
- ✓ Vast range from 4 mm to 20 mm thickness
- ✓ Medium density –more than 1250 Kg/Cu. M.
- ✓ Strength of cement and workability of plywood/wood

Vboard applications includes

- Pre-fabricated houses / Porta cabins
- Partitions in offices, malls, commercial establishments
- Industrial partitions
- Acoustic partitions
- Fire rated partitions
- External cladding
- False ceiling- 'T' grid system
- False ceiling- concealed grid system (Joint-less system)
- Mezzanine flooring, raised flooring, access flooring
- Wet area lining and partitions
- Wall paneling,
- Kitchen cabinets
- Wardrobes
- Doors and door panel inserts
- Roof underlay

partitions

Partitions are usually non-load bearing walls which divides rooms. Steel sections or aluminum may be used to form the frame work. Partition walls constructed from fiber cement are popular throughout the world and used for living room walls, kitchens walls, in wet areas like bathrooms / toilets. Partition frame consists of floor or top channel and studs spaced at 610 mm centers.

Vboard fixing:

Vboard screws fixed to either side of the frame work using self-drilling and tapping screws of CSK head at 200 mm centers. The screws are kept 15 mm (minimum) or 1.5 times the thickness of the board, away from the edge and 40 mm from the corner. A gap of 2mm is to be maintained between the boards. First board will be of 2' / 610mm followed by 1220mm boards on side of the frame work. On the other side start the fixing with 1220mm board followed by 1220mm boards for making the partition more stable and strong. While making an "L" or "T" joint, ensure that **Vboard** is inserted fixed at this junction, between two studs. This will act as a cavity barrier and will not allow smoke (in case of fire) to travel through the cavity.

Insulation: Rockwool slabs of required thickness and in line with the stud dimensions are inserted in the cavity for Insulation purpose.

Jointing and Finishing: Vboard joints can be finished with jointing compound and fiber tape as per recommended practice. Wood primer (water based) is to be used on entire surface before applying putty or paint.

Note: Intermediate channel is fixed horizontal on either side of the frame if the partition height is more than the board length, to provide edge support to the board's edges.

Materials like studs, channels, insulation and their sizes, to be used in a particular partition system are selected from the partition system selector chart.



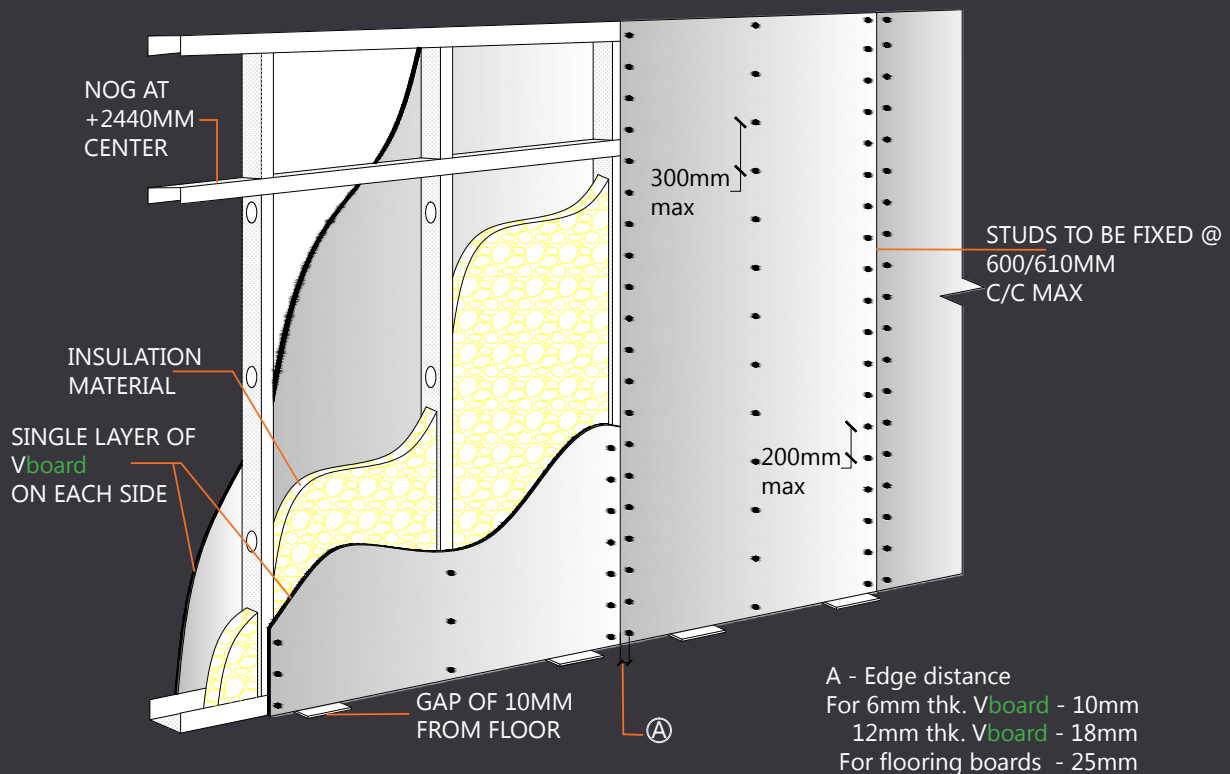

typical fixing details of a fibre cement board in a partition work:



steel frame partitions :

Vboard, A Non-Asbestos Fiber Cement sheet made from cellulose fibres, flyash, cement and some additives is fixed to either side of G.I. Frame using self-drilling screws. These partitions are light weight & Non-Load bearing in nature. They are fast, easy to erect and highly cost effective. These partitions provide for good fire, sound & thermal resistance properties. The design flexibility makes metal frame partitions suitable for most type of buildings, like commercial establishments, industries, airports, malls, villas, farm houses, mini theatres, hotels, hospitals, and studios etc.

The materials used to make a partition are shown here under:

Item		Size in mm.	Application
Floor/top Channel Size 3660 mm long		Web: 50,72,94,148 Flanges: 35 each Thickness: 0.55	Fixed with the floor and slab / soffit using anchor fasteners
Stud- 2440,3000 & 3660 mm long		Web: 48,70,92,146 Flanges: 48 and 50 Thickness: 0.55	Spaced @ 610 mm centers, between floor and top channel / section
Intermediate channel / section- OPTIONAL- 3660 mm long		Web: 45 Flanges: 15 each Thickness: 0.91	Fixed horizontally between the studs if the height of the partition exceeds board length (3050mm).
Self drilling & tapping Screw		25 & 38 long or more as per requirement	Used to screw boards to the frame.

steel frame partition (single layer cladding on either side) :

Non-load bearing steel stud partitions are assembled at site using steel sections to make a frame. **Vboard** of suitable thickness (8mm / 10mm/ 12mm) is fixed to either side of this frame using self-drilling CSK screws of suitable length 25mm/38mm etc. at 200 mm centers, maintaining a gap of 2.0 mm between the boards. The screws are kept 15 mm or 1.5 times the thickness of the board, away from the edge and 40 mm from the corner. Stud dimension will be decided based on the height of the partition.

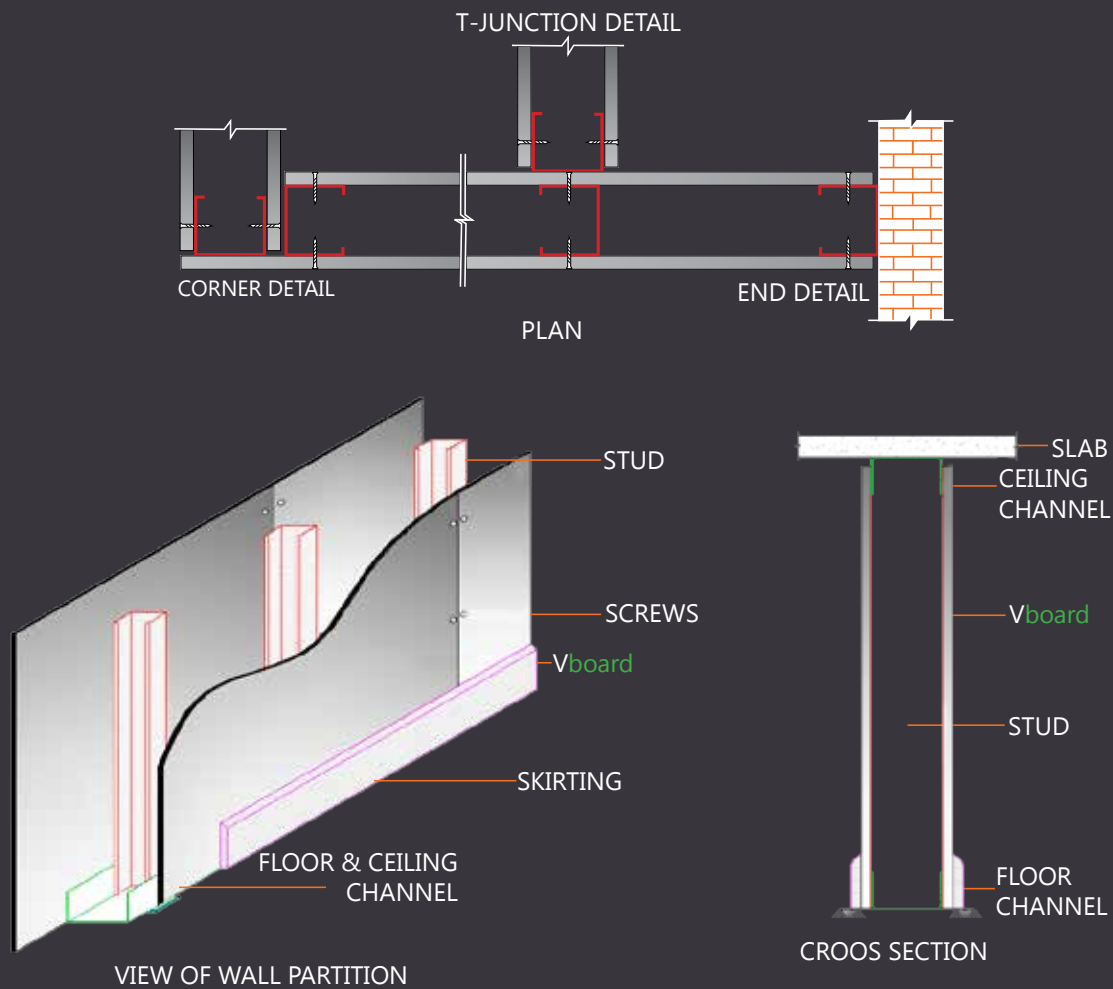

frame work :

Fix floor channel as per the layout plan at 450 mm / 610mm spacing, using nylon sleeve and screws or anchor fasteners of 6mm or 8mm diameter of suitable length. Top channel is fixed to the slab in line and plumb to the floor channel. Studs are then inserted into the floor channel at 601 mm / 611 mm centers. The cut outs provided in the web of studs are kept in a line to accommodate the service pipes like electrical and plumbing in the cavity of the partition. The studs are cut short in length by 5 mm before inserting into the floor channel, to maintain the line and level through-out the length of the partition.

Vboard fixing :

Vboard screws fixed to either side of the frame work using self-drilling and tapping screws of CSK head at 200 mm centers. The screws are kept 15 mm (minimum) or 1.5 times the thickness of the board, away from the edge and 40 mm from the corner. A gap of 2mm is to be maintained between the boards. First board will be of 2' / 610mm followed by 1220mm boards on side of the frame work. On the other side start the fixing with 1220mm board followed by 1220mm boards for making the partition more stable and strong. While making an "L" or "T" joint, ensure that **Vboard** is inserted fixed at this junction, between two studs. This will act as a cavity barrier and will not allow smoke (in case of fire) to travel through the cavity.

Insulation: Rockwool slabs of 50mm or more as per the stud dimension and the recommendations are inserted in the cavity for Insulation (both acoustic as well as thermal) purpose.

Jointing and Finishing: **Vboard** joints can be finished with jointing compound and fiber tape as per recommended practice. Wood primer (water based) is to be used on entire surface before applying putty or paint.

Note: Intermediate channel is fixed horizontal on either side of the frame if the partition height is more than the board length, to provide edge support to the board's edges.

Materials like studs, channels, insulation and their sizes, to be used in a particular partition system are selected from the partition system selector chart.



acoustic partitions using Vboard

STC 45

- Vboard thickness : 8/10 mm, single layer
- Stud detail : C 74 (G.I)
- Stud spacing : 601 mm / 611 mm
- Insulation : Rockwool/Glasswool with
72 mm thk. & Density of 48 kg/Cu.M
- Wall thickness : 90 mm

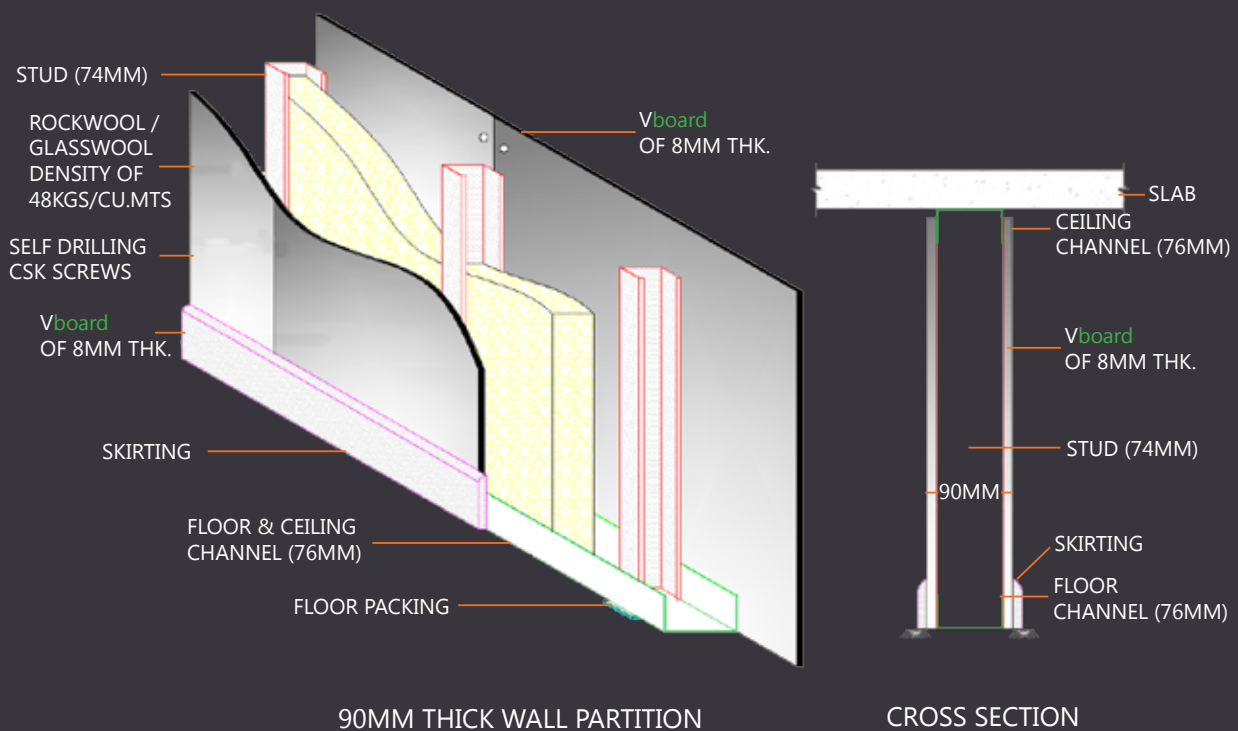

steel frame partition (double layer cladding on either side):

Non-load bearing steel stud partitions are assembled at site using steel sections to make a frame. **Vboard** of suitable thickness (8mm/10mm/12mm) is fixed to either side of this frame in 2 layers using self-drilling CSK screws of suitable length 25mm/38mm etc. at 200 mm centers, maintaining a gap of 2.0 mm between the boards. The screws are kept 15 mm or 1.5 times the thickness of the board, away from the edge and 40 mm from the corner. Stud dimension will be decided based on the height of the partition. These partitions are used to provide enhanced performance in terms of fire resistance, sound insulation.

STC 55:

Vboard thickness	: 10/12 mm, double layer
Stud detail	: C 92 (G.I)
Stud spacing	: 601 mm / 611 mm
Insulation	: Rockwool/Glasswool with 90 mm thk. & Density of 48 kg/Cu.M
Wall thickness	: 132 mm

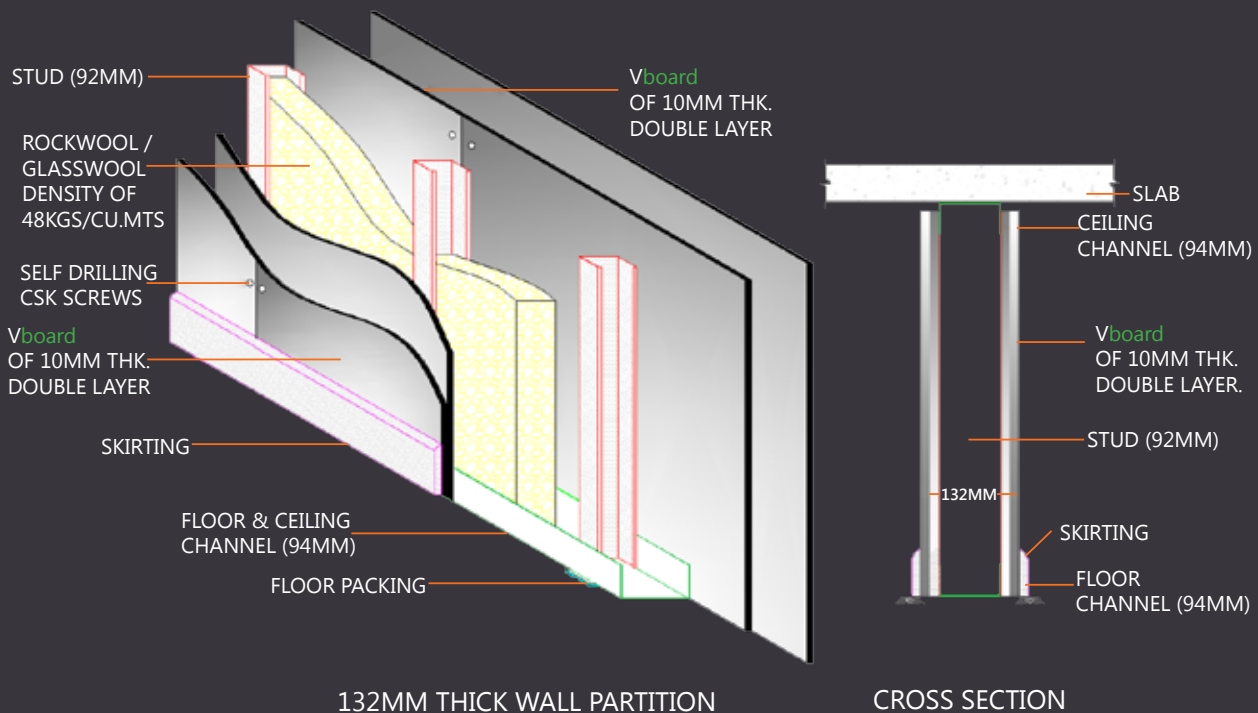

frame work:

Fix floor channel as per the layout plan at 450 mm / 610mm spacing, using nylon sleeve and screws or anchor fasteners of 6mm or 8mm diameter of suitable length. Top channel is fixed to the slab in line and plumb to the floor channel. Studs are then inserted into the floor channel at 601 mm / 611 mm centers. The cut outs provided in the web of studs are kept in a line to accommodate the service pipes like electrical and plumbing in the cavity of the partition. The studs are cut short in length by 5 mm before inserting into the floor channel, to maintain the line and level through-out the length of the partition. (Please refer drawings)

Vboard fixing:

Vboard (1st layer) is screw fixed to either side of the frame work using self-drilling and tapping screws of SCK head at 200 mm centers. The screws are kept 15 mm (minimum) or 1.5 times the thickness of the board, away from the edge and 40 mm from the corner. A gap of 2mm is to be maintained between the boards. First board will be of 2' / 610mm followed by 1220mm boards on side of the frame work. On the other side start the fixing with 1220mm board followed by 1220mm boards for making the partition more stable and strong. Fix the second layer of the boards by the same way by staggering the joints to have better sound and thermal insulation properties and strength. While making an "L" or "T" joint, ensure that **Vboard** is inserted and fixed at this junction, between two studs. This will act as a cavity barrier and will not allow smoke (in case of fire) to travel through the cavity.

Insulation: Rockwool slabs of 50mm or more as per the stud dimension and the recommendations are inserted in the cavity for Insulation (both acoustic as well as thermal) purpose.

Jointing and Finishing: **Vboard** joints can be finished with jointing compound and fiber tape as per recommended practice. Wood primer (water based) is to be used on entire surface before applying putty or paint.

Note: Intermediate channel is fixed horizontal on either side of the frame if the partition height is more than the board length, to provide edge support to the board's edges.

Materials like studs, channels, insulation and their sizes, to be used in a particular partition system are selected from the partition system selector chart.

STC 60:

Vboard thickness : 10/12 mm single layer on each side,
10 mm single layer in the centre.

Stud detail : C 74 (G.I)

Stud spacing : 601 mm / 611 mm

Insulation : two layers of Rockwool/Glasswool with 72 mm thk.
& Density of 48 kg/Cu.M

Wall thickness : 178 mm

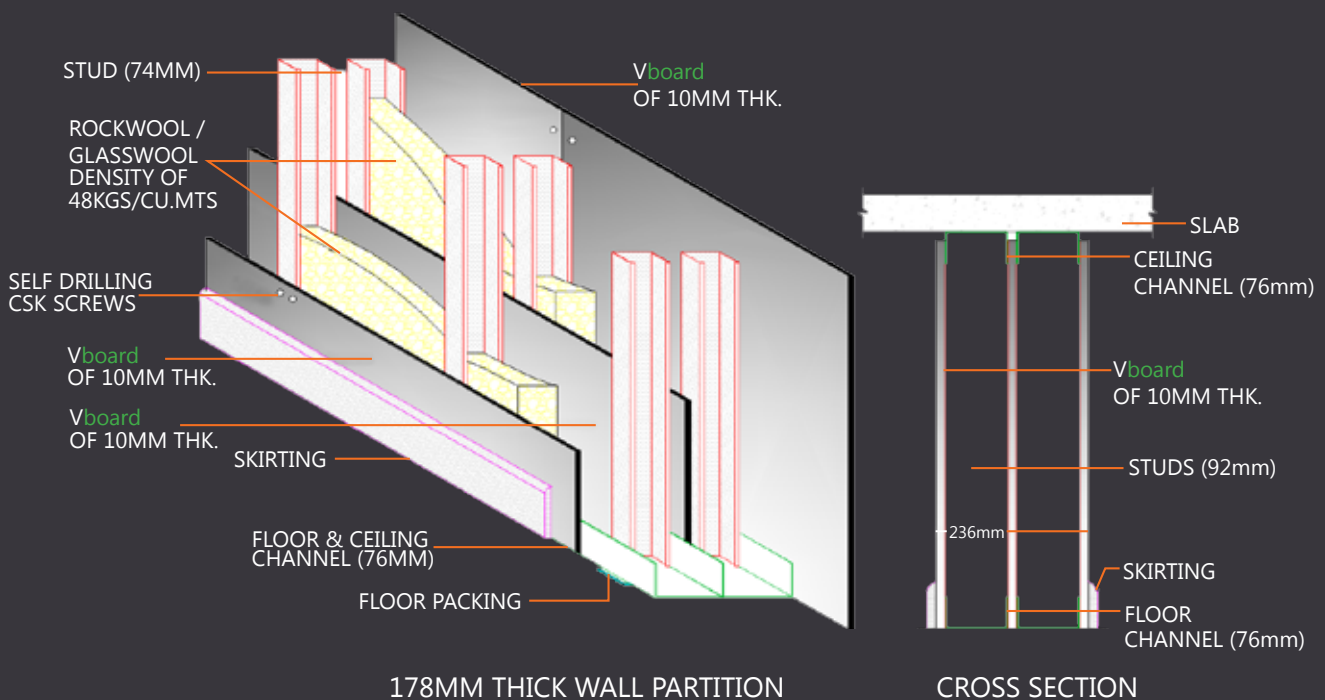

STC 65:

Vboard thickness : 10/12 mm double layer on each side 12 mm single layer in the centre.

Stud detail : C 92 (G.I)

Stud spacing : 601 mm / 611 mm

Insulation : two layers of Rockwool/Glasswool with 90 mm thk.
Density of 48 kg/Cu.M

Wall thickness : 236 / 244 mm

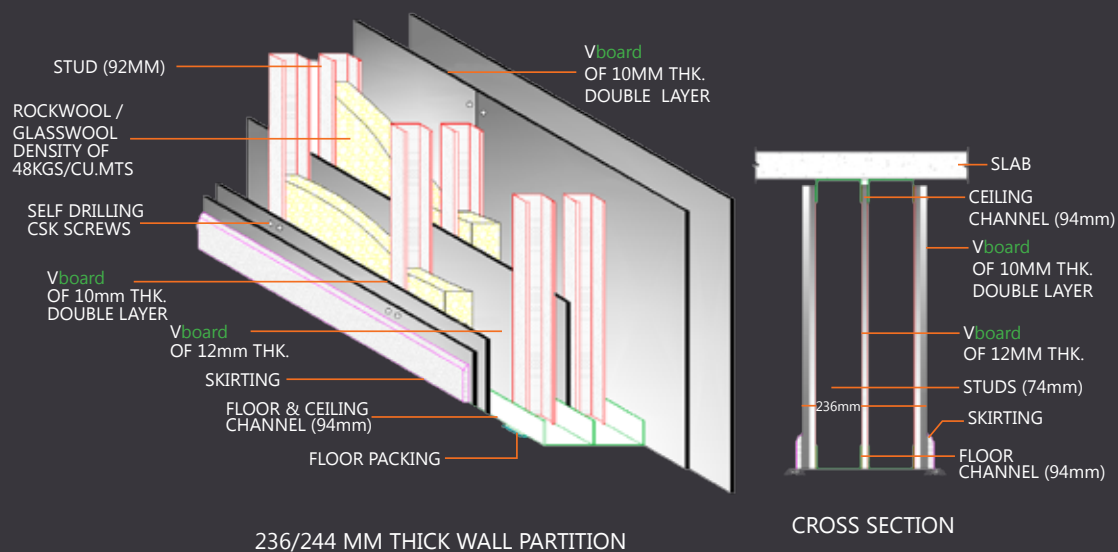

236/244 MM THICK WALL PARTITION

CROSS SECTION

jointing compound preparation

- Mix the paste for 5-10 minutes with putty knife in a plastic container.
- Ensure all the screw heads are driven 0.5 mm below the board's surface.
- Application of jointing compound in a temperature less than 10°C is not recommended.

application of layer - 1

- Clean the recessed portion of the jointing area from dust and other particles and firmly press the 48 mm wide synthetic self-adhesive tape over the full width of recessed portion.
- Make sure that there are no voids under the tape. Immediately cover the tape completely with a thin layer of jointing compound applied with a 100 mm wide knife. Sand and smoothen the surface. Allow the joint to dry for 2 hours.

application of layer - 2

- Once the first layer joint finishing is completely dry, a minimum 200mm wide layer is applied using the same jointing compound spreading a minimum of 75 mm on each side of the recessed joint and is allow to dry for a minimum of 24 hours.
- The layer - 2 of jointing compound must be sanded suitably. After the joints are completely dry, finishing coat is applied. Thoroughly check the undulations of the joint less finish areas using metallic scale or putty knife. The board is now ready for cement primer.

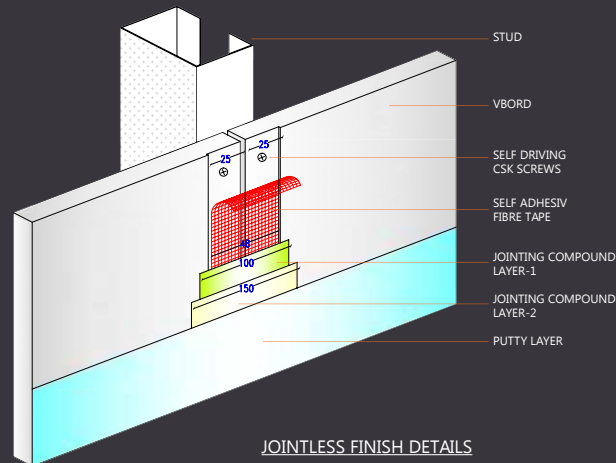

fire resistant partitions using Vboard

Fire resistant partitions can be achieved by using **Vboard** and plaster boards to achieve desired fire ratings. Generally fire rated partitions are non-load bearing in nature. One /Two layers of **Vboard** is screw fixed to either side of frame work using required length of screws at 200 mm centers. The joints of the boards are staggered in each layer and each side to avoid through passage of heat and sound. The material and the number of layers of claddings will be determined as per the requirement of the fire rating. Nearly 3 hours fire rating can be achieved using **Vboard** and plaster board combination (please see the attached drawing).



frame work:

Fix floor channel as per the layout plan at 450 mm / 610mm spacing, using nylon sleeve and screws or anchor fasteners of 6mm or 8mm diameter of suitable length. Top channel is fixed to the slab in line and plumb to the floor channel. Studs are then inserted into the floor channel at 601 mm / 611 mm centers. The cut outs provided in the web of studs are kept in a line to accommodate the service pipes like electrical and plumbing in the cavity of the partition. The studs are cut short in length by 5 mm before inserting into the floor channel, to maintain the line and level through-out the length of the partition.



Exova Warrington fire rating test

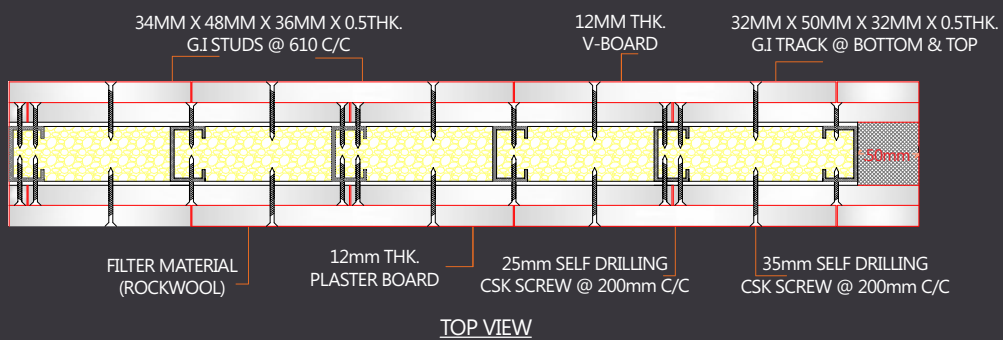
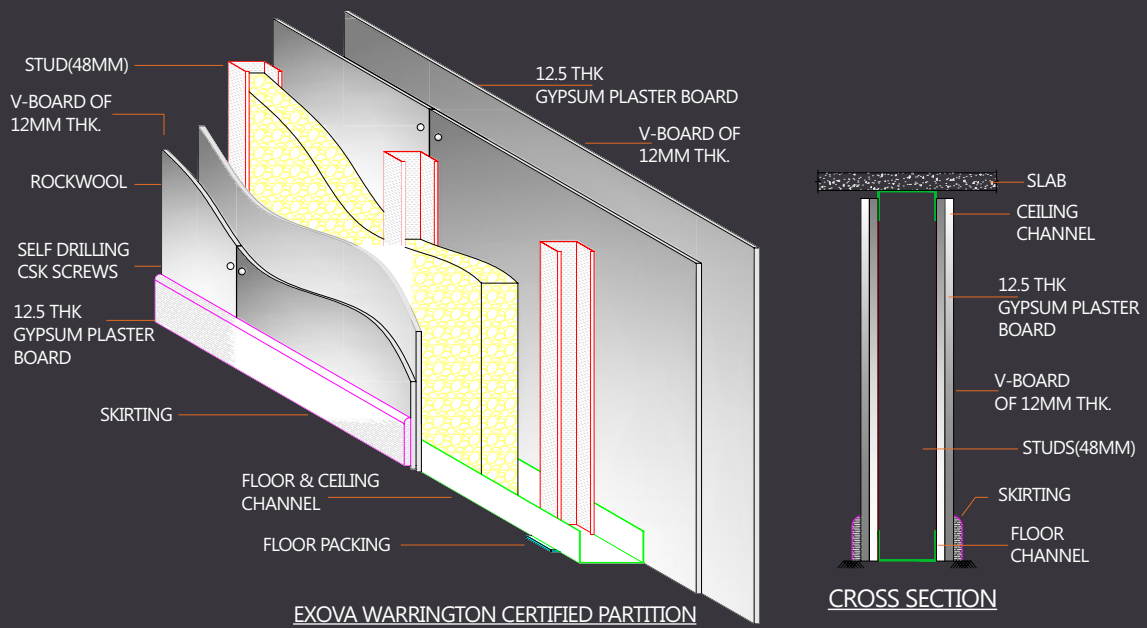

TOP VIEW

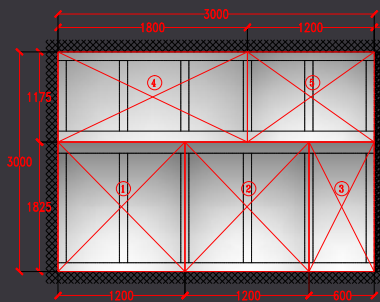

Structural abutment around the partition
Plaster board to be cut as per required size and fixed to G.I. studs and channels using fiber cement screws as supplied.
50mm wide gap filled with mineral wool as per testing requirements and sealed with fiber resistant sealant as suggested acrylic intumescent silicone based sealant

Fixing inner plaster board over G.I framework wall elevation on exposed face

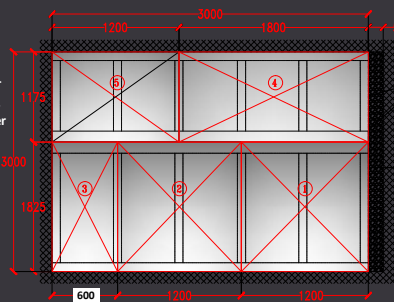

Structural abutment around the partition
Plaster board to be cut as per required size and fixed to G.I. studs and channels using fiber cement screws as supplied.
50mm wide gap filled with mineral wool as per testing requirements and sealed with fiber resistant sealant as suggested acrylic intumescent silicone based sealant

Fixing inner plaster board over G.I framework wall elevation on exposed face

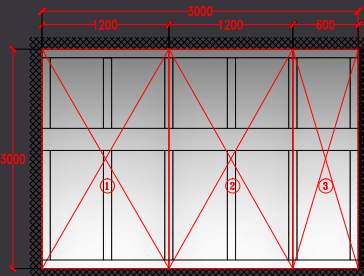

Structural abutment around the partition
2 nos Vboards of 1200 x 3000 size fixed to G.I studs and channels using fiber cement screws as supplied
50mm wide gap filled with mineral wool as per testing requirements and sealed with fiber resistant sealant as suggested acrylic intumescent silicone based sealant

Fixing outer Vboard over inner plaster board wall elevation on exposed face

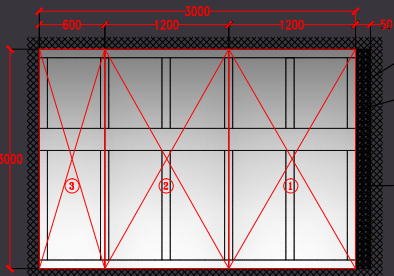

Structural abutment around the partition
2 nos Vboards of 1200 x 3000 size fixed to G.I studs and channels using fiber cement screws as supplied
50mm wide gap filled with mineral wool as per testing requirements and sealed with fiber resistant sealant as suggested acrylic intumescent silicone based sealant

Fixing outer Vboard over inner plaster board wall elevation on exposed face

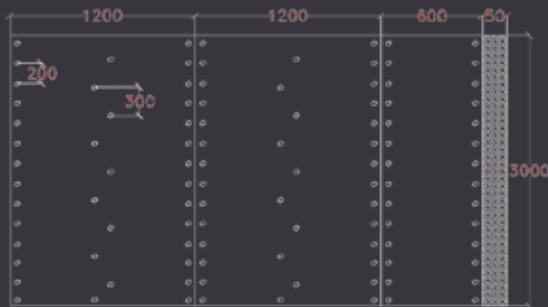

Placement and fixation of screws on side -A

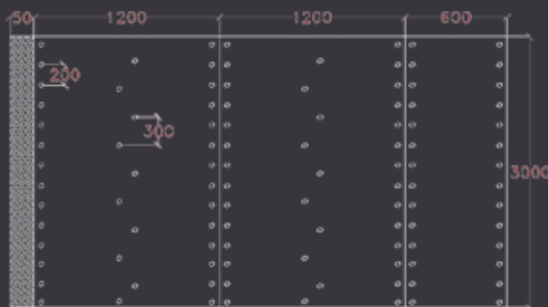

Placement and fixation of screws on side -B

1. All inner & outer boards interfacing joints are to be filled with fire rated sealant.
2. This fire rated sealant is also to be applied on screw heads and gap between dry wall constructed with Vboard and the abutting masonry wall.
3. The voids of the partition system is to be filled with mineral wool of 50mm thk. and of 64kgs/CU.MT density. The placement of the mineral wool blocks of size 1.0m x 0.6m is to be placed taking care the same will not roll back. This can be achieved either by fixing with chicken mesh or holding it vertically in position covering the void.
4. The inner part of the test specimen consists of 12mm thick plaster board on both sides of studs, top & bottom channels, these two boards are attached to this frame work with self tapping screws of 35mm/25mm placed at 200/300mm apart as per drawing.

All Dimensions Are In mm

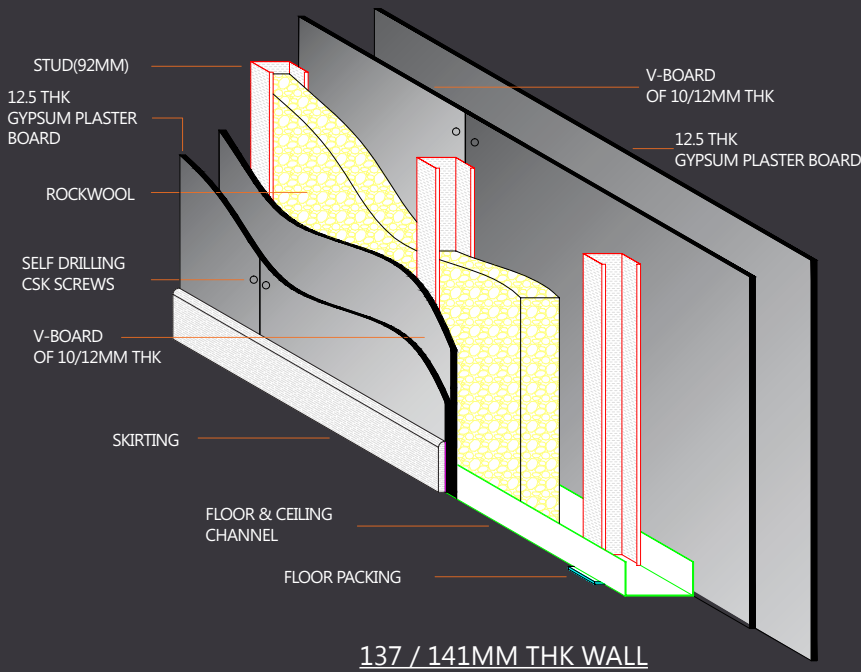

137 / 141MM THK WALL

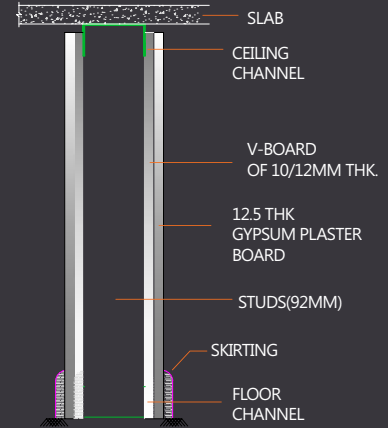

CROSS SECTION

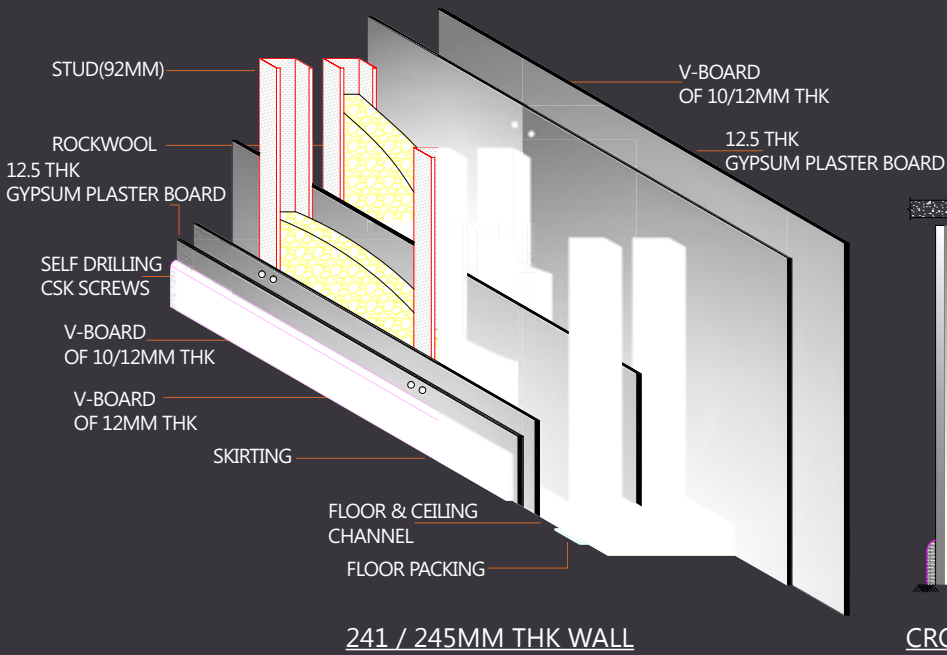

241 / 245MM THK WALL

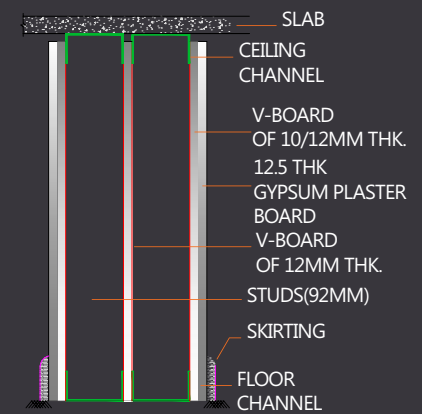

CROSS SECTION

false ceiling systems using Vboard

Vboard "Tee" grid system



"Tee" grid system is more popular in false ceilings in office, commercial establishments, and wet areas in residential as well as commercial buildings. It is economical, easy to erect frame work. The Tee grids are available in Pre-coated steel. Easy to maintain in case of repairing/ maintenance. The boards can easily be laid into the grid and can be replaced easily, whenever required

Item		Size in mm.	Application
Main "T" -3600		Base: 24 Height: 38 Thickness: 0.60	Suspended from the slab @1200 mm c/c with level clip.
Cross "T" -1200		Base: 24 Height: 27 Thickness: 0.60	Inserted in to the fixed slots of main "T" @ 600 mm to form a grid of 1200 x 600 mm.
Cross "T" - 600		Base: 24 Height: 27 Thickness: 0.60	Inserted into the slots of cross "T" @600 mm to form a grid of 600 x 600 mm
Wall Angle		Flange: 22 each Thickness: 0.45	Fixed to the perimeter of the wall / partition.
Level clip with wire.		Wire dia. 4 mm	Used @ 1200 mm c/c to hold the main "T"
Soffit Cleat		Web: 25 Flange: 27 & 25 Thickness: 1.8	Used to suspend level clip with wire.
Anchor Fastener		38 x 12 dia.	Used @1200 mm c/c in both directions

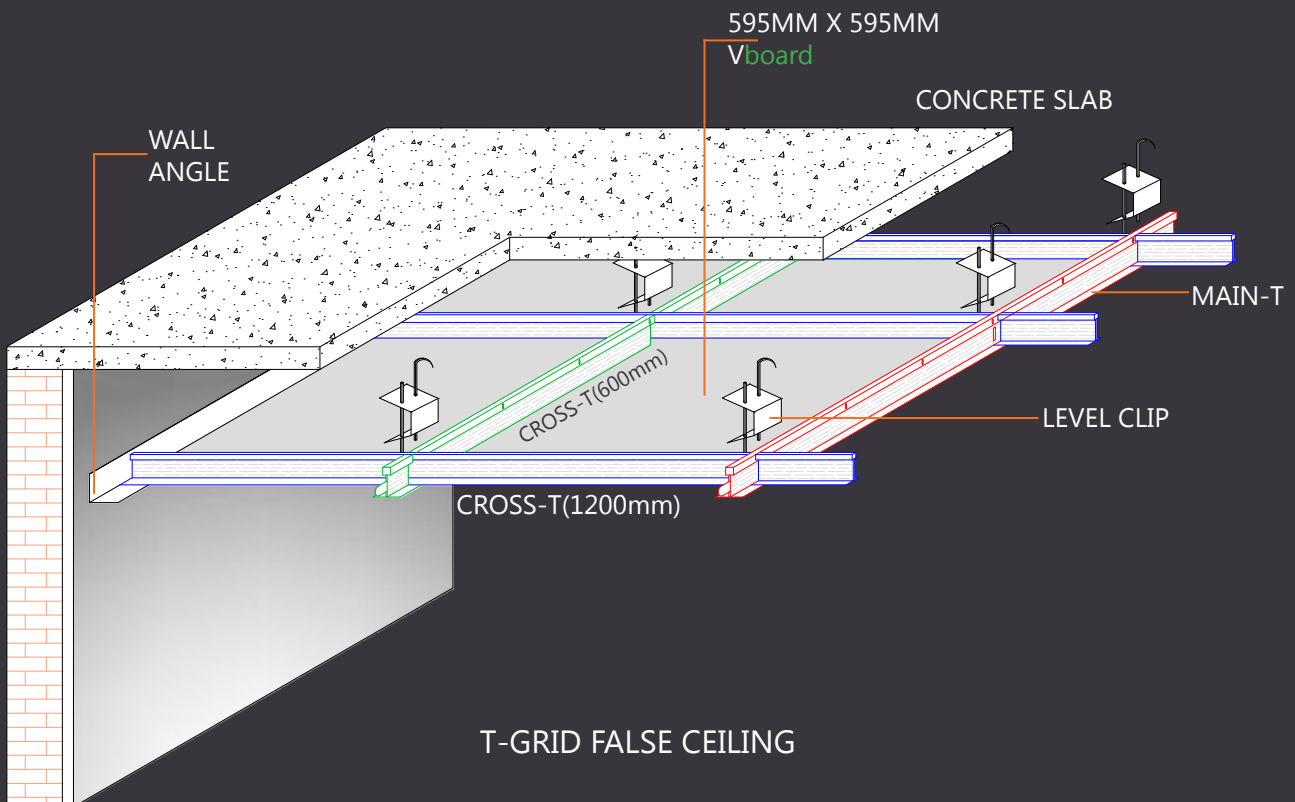

"tee" grid frame work:

Step-1: Ceiling level is marked on the partition / brick wall as per the drawing.

Step-2: Pre-coated steel L angle 25 x 25 mm is fixed to the wall / partition to the marked line with nylon sleeves and screws of 7g /10g x 38 mm length at 450 / 610 mm centers.

Step-3: Main "T" sections are suspended from the slab at 1220 mm centers. Cleat fasteners, 4 mm thick wire and level clip are used for suspending main "T".

Step-3: 1200 mm long cross "T" sections are then clipped to the main "T" sections at 600 mm centers and locked together to form a grid of 1200 x 600 mm.

Step-4: 600 mm long cross "T" sections are inserted and to form a grid of 600 x 600 mm.

Step-5: 595mm x 595mm **Vboard** (plain or designer) is placed in the grid work to complete the false ceiling. Boards are to be primer coated before laying in the grid.

Vboard concealed grid false ceilings



False ceilings are used to minimize load (Power consumption) on air-conditioning in a building and also to provide an esthetic look to the soffit/ roof. False ceilings can be concealed grid (Flush finish) where boards are fixed to the frame and finished to provide seamless surface or exposed grid type where tiles are laid into the grid. Boards can also be fixed by providing groove all around the board.

Item		Size in mm.	Application
Perimeter Channel		Web: 26 Flange: 20 & 30 Thickness: 0.55	Fixed to the perimeter of the wall / partition
Intermediate Channel		Web: 45 Flange: 15 each Thickness: 0.91	Suspended from the soffit @ 1220 mm c/c with rawl plug, soffit cleat and ceiling angle.
Ceiling Section		Web: 51.5 Flange: 22 each Thickness: 0.55	Fixed to the intermediate channel @ 300 mm c/c with connecting clips , to hold the boards
Ceiling Angle		Flange: 10 & 25 each Thickness: 0.55	Used to suspend Intermediate channel from soffit cleat.
Connecting Clip		2.60 dia.	It is used to hold the ceiling section to the intermediate channel
Soffit Cleat		Web: 25 Flange: 27 & 25 Thickness: 1.8	Used at 1220 mm c/c to the rawl plug to suspend ceiling hanger.
Metal fasteners		12.5 dia.	Used @ 1220 mm c/c in both direction
CSK self drilling & tapping screws with under head cutter.		25 & 35 long	Used to fix boards to the metal frame @200 mm c/c (12 mm away from the edge and 40 mm from the corners.)

Ceiling level is marked on the wall/ partition as per the drawing, and fix G.I. Perimeter channel to the perimeter of the wall/ partition with nylon sleeves and screws (38 mm long or more) at 610 mm centers, at the required level.

Line mark is done at 1220 mm intervals in both the directions to form a 1220 x 1220 grid. At the intersection point of these lines, drill hole of 13mm diameter using hammer drill machine and insert fastener of 12 dia. x 38 mm with one leg of soffit cleat attached to it, and tight the fastener fully.

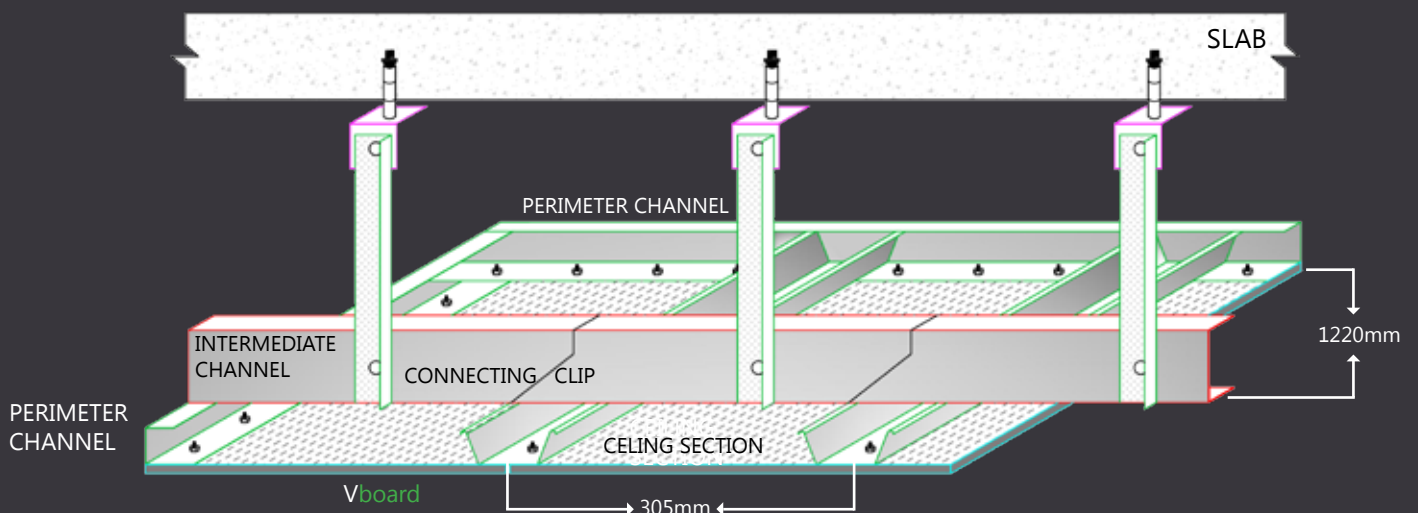
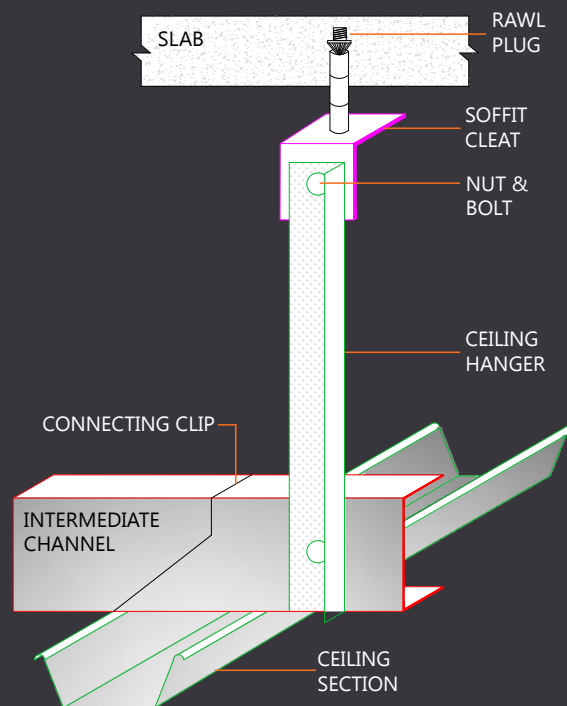

Cut 150mm long G.I. Angle of size 25 x 10 mm. One end of the angle is fixed to the soffit cleat and other to the Intermediate channel by 6mm diameter, 12mm long nut and bolt.

Intermediate channels are suspended at 1220 mm centers in line and level. For long rooms, overlap the channels by 150mm or more to increase the length and bolt them with 6x12mm bolts. Ceiling sections are fixed to the Intermediate channel at 305 mm centre in perpendicular direction to it with the help of connecting clips. Overlap the ceiling sections by 150mm wherever required to increase the length of ceiling section and screw them at 4 places.

Openings for light fittings / AC grills etc. can be formed by using perimeter channel /section all around the opening.

Vboard of 8mm thick 1220mm x 2440mm / 3050mm are used for the false ceiling application. The installation procedure is as follows:

Step-1: The recessing of size 40mm x 1.5mm on board is done if square edge boards are supplied.

Step-2: The boards are fixed to the ceiling sections using self-drilling CSK screws of 7g x 25mm @ 200mm intervals in the same direction to the framing so that **Vboard** will have a continuous support. Extra ceiling section will be fixed wherever required to support the boards.

Step-3: A gap of 2 to 3 mm is provided between the boards.

Step-4: The CSK screws should be fixed from the edge least 1.5 times the thickness of board (centre of the screw) and 40mm from the corners at an interval of 200 mm.

Step-4: The CSK screws should be fixed from the edge least 1.5 times the thickness of board (centre of the screw) and 40mm from the corners at an interval of 200 mm.

Step-5: The joints between the boards are staggered in brick pattern if permitted by Architect for better strength, otherwise fix it straight line to have uniform groove finish.

Access cutouts are provided in suspended ceilings for repairs/maintenance purpose. These can be made by providing additional perimeter channel and intermediate section around the opening. **Vboard** is then fixed to the frame work with self drilling screws.

jointing finish:

Vboard joints are finished with jointing compound and fiber tape to get joint-less finish. Water based wood primer is applied on entire surface before applying putty or paint.



wall paneling/ lining using **Vboard/ Vdesigner**

Wall panelling / lining is one of the most successful and useful application of **Vboard/Vdesigner**. For Wall panelling, a **Vboard/Vdesigner** can be screw fixed to the existing wall by using nylon sleeves and wood screws at 300 mm centers. 6 mm / 8 mm thick **Vboard** OR 6mm **Vdesigner** are used for this purpose. Line and level should be checked while fixing the frame work so that an aesthetically good looking wall panelling is achieved. One coat of wood Primer (water based) is applied on all sides of the board before doing any Painting. If final surface is to be finished with lamination / wall paper on **Vboard**, then don't do primer coating on the surface (facing side).

Vboard/Vdesigner can be used for making wall lining to cover seepages of the brick walls by using the same method.

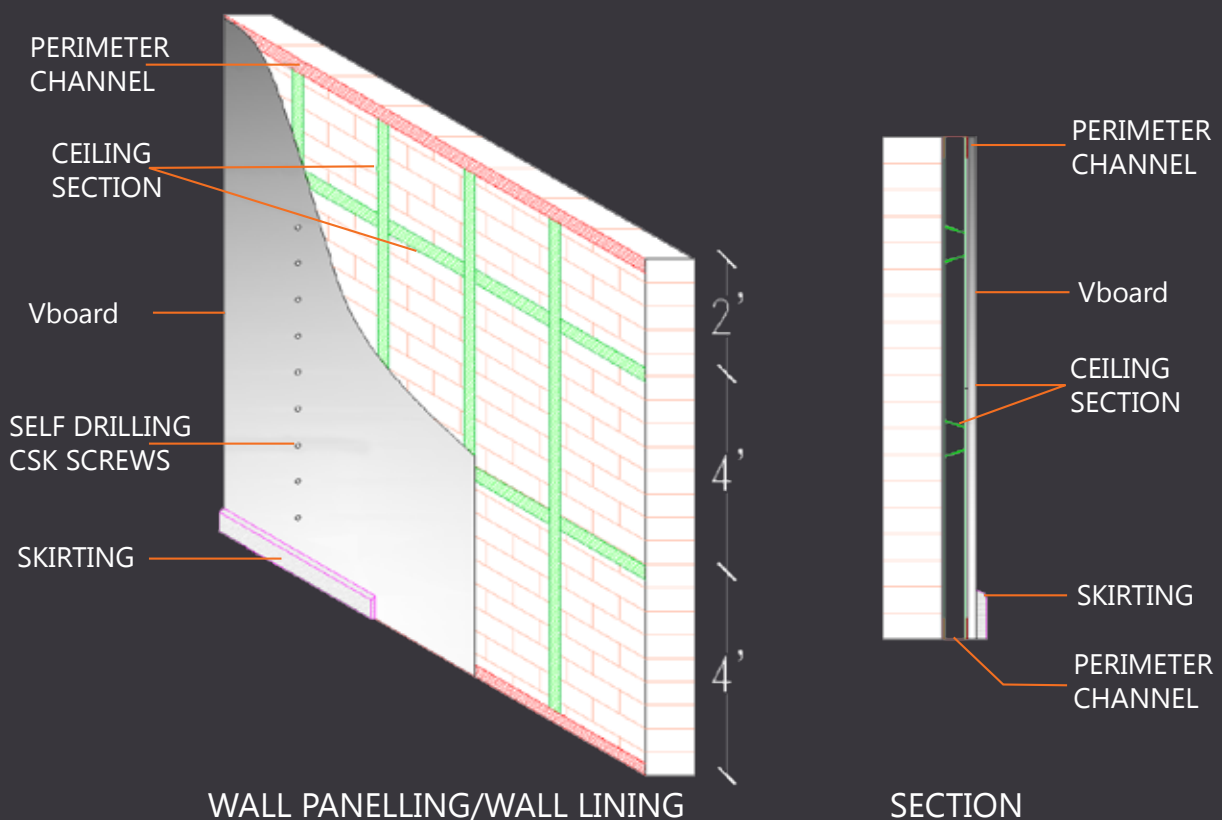

materials:

Materials	Size in mm	Application
Perimeter Channel	Web: 26 Flange: 20 & 30 Thickness: 0.55	Fixed to the floor & ceiling.
Ceiling Section	Web: 51.5 Flange: 22 each Thickness: 0.55	Inserted fixed in to the perimeter Channel @ 610 mm centers to receive the Vboard .
CSK self-drilling & tapping CSK screws with under head cutter.	25, 35, 42 mm	Used to fix Vboard to the frame.

Step 1: Mark the line on the wall to fix the perimeter channels and ceiling sections.

Step 2: Fix Perimeter channel along with this line to the wall.

Step 3: Insert ceiling section between the two perimeter channels @ 610 mm centers.

Step 4: cross check the plumb and fix the inserts where ever required behind the perimeter channel / ceiling section.

board fixing :

Step 1: The boards are screw fixed to the frame by using 25 mm long self-drilling CSK screws with under head cutter at 200 mm centers.

Step 2: The screws should be 15 mm away from the edges and 40 mm from the corner.

Step 3: A gap of 1.5 to 2 mm is provided between the boards.

jointing and finishing :

Vboard joints are finished with jointing compound and 48 mm wide, fiber tape to get seamless finish. Cement primer (oil based) is applied on entire surface before applying putty or paint.

mezzanine flooring

Vboard is often used as a flooring material as a replacement to conventional flooring system. 15mm or 18mm or 20mm is generally used as a flooring material in Mezzanine, Raised Flooring, and False flooring applications.

Framing Work: RHS / SHS sections of TATA make or equivalent or traditional structural materials like angles and channels are used as steel grid work. Please refer table for the recommended steel section details.

Vboard Cladding: As per the desired live load, **Vboards** of suitable thickness is laid on the steel grid. Boards are fixed to the steel grid using self-drilling self-tapping CSK screws of at least 10g or above of suitable length. Spacing between the screws should 200mm or less. Care should be taken to ensure that there is a support behind the boards' joints. Edge distance of 1.5time the thickness should be maintained to avoid edge cracking of the boards.**Vboard** flooring should be covered with finish materials like Vinyl Flooring, Vitrified tiles, carpet, wooden flooring etc. For heavy traffic areas we recommend to use 2 layers of **Vboard** in staggered manner to achieve best results.



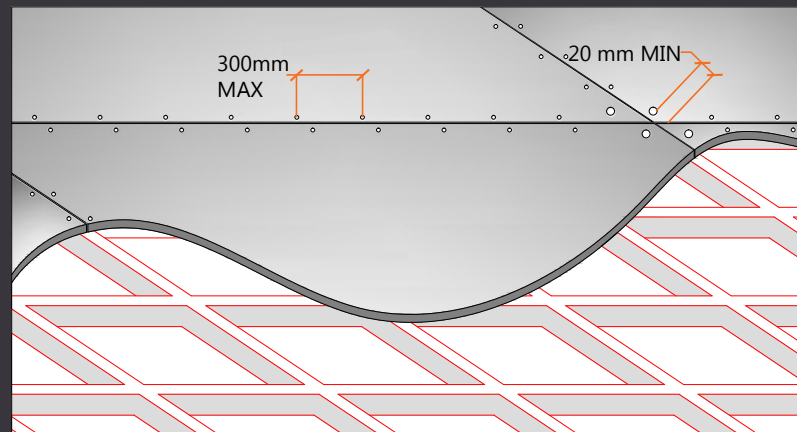

MEZZANINE FLOORING

load table for fibre cement boards (dry area)(for single layer)

Sheet thickness	Span mm	Allowable UDL(kg/sqm (2 to 3 supports)	Allowable point load Multiple supports	Allowable point load(kg)	Suggested sections
18mm	300	350	550	275	ISA 65x65x6/RHS96x48x4.8
20mm	300	410	700	310	ISA 65x65x6/RHS96x48x4.8
18mm	400	280	420	235	ISMC100/RHS96x48x4.8
20mm	400	350	510	330	ISMC150/RHS122x61x4.5
18mm	600	150	175	175	ISMB150/RHS 145x82x4.8
20mm	600	200	225	225	ISMB200/RHS172x92x4.8

thermal insulation

Thermal conductivity with symbol "K" and with unit of measurement as W/m K. Thermal Conductivity is the measure of a materials ability to transmit heat.

Generally denser materials have a high thermal conductivity value and are inefficient thermal insulating materials.

Light-weight materials have low conductivity and act as effective thermal insulating materials. Lower the "K" value of a material, the better is its insulating efficiency.

The R-value is a measure of thermal resistance used in the building and construction industry. The R-value being discussed is the unit thermal resistance. This is used for a unit value of any particular material. It is expressed as the thickness of the material divided by the thermal conductivity.

thermal resistance:

Thermal resistance is the measure of the resistance to the passage of heat offered by the thicknes of a material and is expressed as m^2K/W . Thermal resistance of material is obtained by dividing thickness of material in meter by its thermal conductivity (K) value. ($R = \text{Thickness in meters} / K \text{ value}$)

$R \text{ (total) of the Partition} = R \text{ value of individual elements (Boards, insulation, air inside and air outside)}$

thermal transmittance (u):

Thermal transmittance of a building element is a property of its whole construction including air spaces and is the measure of its ability to transmit heat under steady state condition. It is calculated by taking reciprocal of the sum of all the individual thermal resistances. It is expressed as W/m^2K .

Lower the (U) value of the element, the better is its thermal insulation.

$U \text{ value} = 1 / R_1 + R_2 + R_3 + \dots$ (where R_1, R_2, R_3, \dots are thermal resistance of different elements of building / construction)

conversion factor for thermal insulation calculation:

The conversion between SI and US units of R-value is
 $1 \text{ h}\cdot\text{ft}^2\cdot^\circ\text{F}/\text{Btu} = 0.176110 \text{ K}\cdot\text{m}^2/\text{W}$,

OR

$1 \text{ K}\cdot\text{m}^2/\text{W} = 5.678263 \text{ h}\cdot\text{ft}^2\cdot^\circ\text{F}/\text{Btu}$.

More simply, R-values may be converted from SI to US units through the following, where RSI is given in metric units. $R\text{-value (US)} = \text{RSI} \times 5.678263337$

Or converted from US units to SI units, where R-value is given in imperial units.

$\text{RSI (SI)} = R\text{-value} \times 0.1761101838$

calculation of thermal resistance (r) & thermal transmittance (u) thermal conductivity (k) of building materials

Material	K W/mts. * K
Vboard	0.172
Rockwool	0.045
Plaster board	0.170
Brick dry	0.807
Common brick wall	1.154
Concrete	1.442
Fibre board	0.052
Glass sheet	1.053
Polystyrene EPS (expanded)	0.035
Polyurethane PUF (foam)	0.024
Plywood	0.138

Vboard partition

Vboard THICKNESS : 8 mm, single layer

STUD DETAIL : C 74 (G.I)

STUD SPACING : 601 mm / 611 mm

INSULATION : Rockwool with 50 mm thick & density of 48 Kg/Cu. Mts.

TOTAL WALL THICKNESS : 90 mm

R value calculation of Vboard partition

Thermal conductivity (k) of Vboard = 0.172 W/mts. * K

Thermal resistance (R) of 8 mm thick Vboard = Thickness in meters / 0.172 Sq.mt * K/W
= 0.008 / 0.172

Thermal resistance R (Vboard) = 0.0465 Sq.mt * K/W

Thermal resistance R (inside surface) = 0.123 Sq.mt * K/W

Thermal resistance R (outside surface) = 0.055 Sq.mt * K/W

Thermal resistance R (Rockwool of 50 mm thick) = 1.11 Sq.mt * K/W

Total Thermal resistance R (90 mm wall) = R(OS) + R(VB) + R(RW) + R(VB) + R(IS)
= 0.055 + 0.0465 + 1.11 + 0.0465 + 0.123

Therefore, R (total) = 1.381 Sq.mt * K/W

Thermal transmittance (U) = 1/R

= 1/1.381

Thermal transmittance U (90 mm thick wall) = 0.724 W/ Sq.mt *K.

calculation of u – value for a 6" thick brick wall:

U - Value for the 150 mm brick wall with 16 mm plaster on either surface.

Assume normal exposure.

Brick (k) = 0.84 W/mts. * K

Plaster (k) = 0.50 W/mts. * K

Brick resistance, (R) = 0.137 Sq.mt * K/W

Plaster resistance (R) = 0.032 Sq.mt * K/W

R (inside) = 0.123 Sq.mt * K/W

R (outside) = 0.055 Sq.mt * K/W

Hence, Total resistance = 0.123 + 0.032 + 0.137 + 0.032 + 0.055

Therefore, R (total) 6" Brick wall = 0.379 Sq.mt * K/W

Thermal transmittance (U) = 1/R

= 1/0.379

Thermal transmittance U (6" wall) = 2.638 W/ Sq.mt *K.

calculation of u – value for a 9” thick brick wall:

U - Value for the 260 mm brick wall with 16 mm plaster on either surface.
Assume normal exposure.

$$\text{Brick (k)} = 0.84 \text{ W/mts. * K}$$

$$\text{Plaster (k)} = 0.50 \text{ W/mts. * K}$$

$$\text{Brick resistance, (R)} = 0.272 \text{ Sq.mt * K/W,}$$

$$\text{Plaster resistance (R)} = 0.032 \text{ Sq.mt * K/W}$$

$$\text{R (inside)} = 0.123 \text{ Sq.mt * K/W}$$

$$\text{R (outside)} = 0.055 \text{ Sq.mt * K/W}$$

Hence,

$$\text{Total resistance} = 0.123 + 0.032 + 0.272 + 0.032 + 0.055$$

$$\text{Therefore, R (total) 9” Brick wall} = 0.514 \text{ Sq.mt * K/W}$$

$$\text{Thermal transmittance (U)} = 1/R$$

$$= 1/0.514$$

$$\text{Thermal transmittance U (9” wall)} = 1.945 \text{ W/ Sq.mt *K.}$$

S.NO	PROPERTY	90mm Vboard Partition	6” Brick Plastered Wall	9” Brick Plastered Wall
1	“R” Value- sq.mtr * K/W	1.381	0.379	0.514
2	“U” Value- W/sq.mtr * K	0.724	2.638	1.945

NOTE: Higher the “R” value better the system, Lower the “U” value better the system.

It is imperative that our 90mm thick partition is better by 4 times when compared to hal brick wall.

external cladding using Vplank :

(Vplank manufactured as per ISO 8336/IS 14862 Type "A" Category '3' / ASTM C 1186 Type "A" Grade II Fiber Cement Boards Standards)

One of the most popular applications of the Vpremium board is external cladding. External cladding is done either on the existing walls or on steel / G.I / Aluminum frame. For this application we use Vplank which is designer fibre cement boards having dimensions of 150mm width and 8mm thick with wood grains design on the facing sheet. Maximum length of the plank is 3050mm. These planks gives an appeal of teak wood finish. Planks fixed horizontally on the frame work is called siding. Painted with an exterior grade plastic/acrylic based paint will give a look of natural wood.

application/fixing of Vplank :

Frame work of required material is done on the existing walls or on steel / G.I / Aluminum frame. Once the frame work is done with studs spacing @ every 305 / 300mm, the frame grid is ready to take the planks cladding. 1 st plank of 150mm wide is fixed straight on the frame work using self-drilling CSK screws. Next plank is over lapped on to the 1st plank by 1" (25mm) so that the screws of the 1st planks are concealed by the overlap. Continue the process till the last plank. Cover the screws of the top most plank with acrylic putty. (Please refer the drawing for fixing details). Paint the planks using the exterior grade paint and polish to give a natural wood finish.



typical Planks fixing details

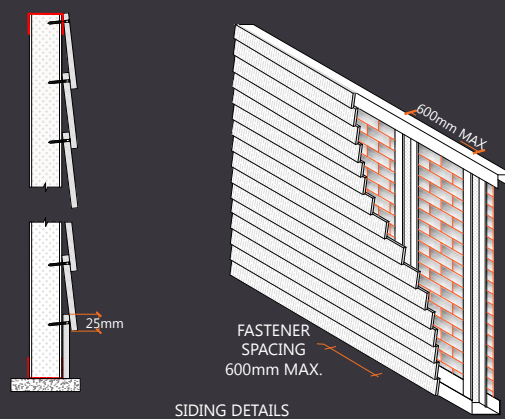

external and internal cladding using **Vpremium** board for LGSF (Light Gauge Steel Frame) structures:

*(**Vpremium** manufactured as per ISO 8336/IS 14862 Type "A" Category '3'/ASTM C 1186 Type "A" Grade II Fiber Cement Boards Standards)*

In international market LGSF (Light Gauge Steel Frame) is one of the most popular ways of constructing the structures for use as residential and commercial applications like villas, resorts, week end homes, institutions, health care centres, schools, etc.

In all these applications, the **Vpremium** board variants of 9mm / 10mm thick (fibre cement boards – asbestos free) are used as primary skin due to its natural strengths. Second layer on exterior side is generally opted as planks as siding to give a wood house feel for residential applications like resorts, villas, week end homes. Otherwise 2nd layer will be with any other product like stone, tiles, and 10mm thick **Vpremium** board or natural wood. Second layer on interior side is finished with 8mm thick **Vpremium** board in wet areas like kitchen and toilets. As an alternative, plaster boards can be used as a second layer for joint-less finish in non-wet areas like living rooms, drawing rooms, bed rooms, school class rooms, etc. The screws spacing, gauge and all other technical parameters will remain unchanged since the application is cladding work.



technical & physical specifications

(Vpremium and Vplank manufactured as per ISO 8336/IS 14862 Type "A" Category '3'/ ASTM C 1186 Type "A" Grade II Fiber Cement Boards Standards)

S.No.	Property	Test Method	Unit	Requirement	Test Results
Physical Characteristics					
1.	Dimensional Tolerances:				
a.	Length & Width	ASTM C1185/		± 0.5%	Pass
b.	Thickness	IS14862 /		± 10%	Pass
c.	Straightness & Squareness	ISO 8336		3mm/m & 4mm/m	Pass
2.	Density	ASTM C1185	Kg /m3	>1250	1298
3.	Flexural Strength (MOR – Wet Condition)	ASTM C1185	N/mm2	> 7.0	8.8
4.	Water Impermeability	ASTM C1185		No water droplets at the underside	Pass
5.	Moisture Movement	ASTM C1185	%		0.061
6.	Water Absorption	ASTM C1185	%	30-36	30.64
7.	Moisture Content	ASTM C1185	%	4-8	4
8.	Water Vapour Transmission	ISO 12572	g/m2. Perday		40.6
	Water Vapour Resistance Factor (μ)				117
9.	Glue-Line Shear Force/Strength	ASTM D1037	N		3264.2
10.	Direct Screw Withdrawal Resistance	ASTM D1037	N		989.7, 643.3
Durability					
11.	Freeze-Thaw resistance (50 cycles)	ASTM C 1185			Pass
12.	Warm water resistance	ASTM C1185			Pass
13.	Soak-Dry resistance (50 cycles)	ISO 8336			Pass
14.	Heat-Rain resistance (25 cycles)	ASTM C1185			Pass
FIRE					
15.	Ignitability	BS 476, Part 5		Class P - not easily Ignitable	Class P
16.	Fire Propagation Index	BS 476, Part 6		Lower Values are better	2.79
17.	Surface Spread of Flame	BS 476, Part 7			Class 1
18.	Fire Resistance – Integrity & Insulation (in minutes for Non-load bearing, Insulated double-skin partition)	BS 476, Part 22	Both in minutes	>120	171 & 148
19.	Surface Burning Characteristics :	ASTM E84		Lower Values are better	
a.	Flame Spread Index				0
b.	Smoke Developed Index				0
c.	Class				A
Acoustic Characteristics					
20.	Sound Transmission Coefficient (STC) :	DIN 52210 /			
a.	Bare Board (8mm thick)	ISO 140	dB		29
b.	Typical Partition (with 10mm facing sheets, 72mm stud, 50mm glass wool 48kg/m3)		dB		45
Thermal Characteristics					
21.	Thermal Conductivity	ASTM C518	W/m ⁰ K Kcal/mh ⁰ K		0.0748 0.0643

technical & physical specifications

(Vboard manufactured as per IS - 14862:2000, Type B Category '3')

S.No.	Properties	Units	Performance
Physical Characteristics			
1	Apparent Density	Kg/m ³	>1200
2	Standard Weight (For 6mm)	Kg/m ²	8.9
3	Thickness of boards (Range)	mm	4 to 25
4	Dimensions of the boards	mm	1220 x 1830, 1220 x 2440, 1220 x 2745 and 1220 x 3050
Mechanical Characteristics			
5	Modulus of rupture EMC - Minimum	MPa or N/mm ²	10
6	Free Moisture Content	%	6
7	Water absorption - 22 Hrs.	%	36
8	Lamina Bond Strength	MPa or N/mm ²	0.9
Additional Characteristics			
9	Thermal Conductivity (K) (30° C Mean Temperature)	W/m .k	0.172
10	pH value		10.4
11	Acoustic insulation	dB	8mm thick Vboard-29 dB
12	Screw Withdrawal (On face)	N	1220
13	Nail Withdrawal (On face)	N	1010

application matrix

Application	Thickness (mm)										
	4	6	8	9	10	12	14	16	18	20	25
Internal											
False Ceiling	✓	✓	✓								
Wall Partitions			✓	✓	✓	✓					
Wall Panelling		✓	✓	✓							
Mezzanine Flooring									✓	✓	✓
Doors					✓	✓	✓	✓			
Wet areas					✓	✓					
Kitchen Cabinets/ Wardrobes/Shelves								✓	✓		
External											
Prefab Structures			✓	✓	✓	✓					
Wall Cladding			✓	✓	✓	✓					
Sign Boards			✓		✓						
Roof Underlay						✓	✓	✓			
Duct Covering						✓					

TYPICAL FIXING DETAIL OF LCD/SPLIT A.C.

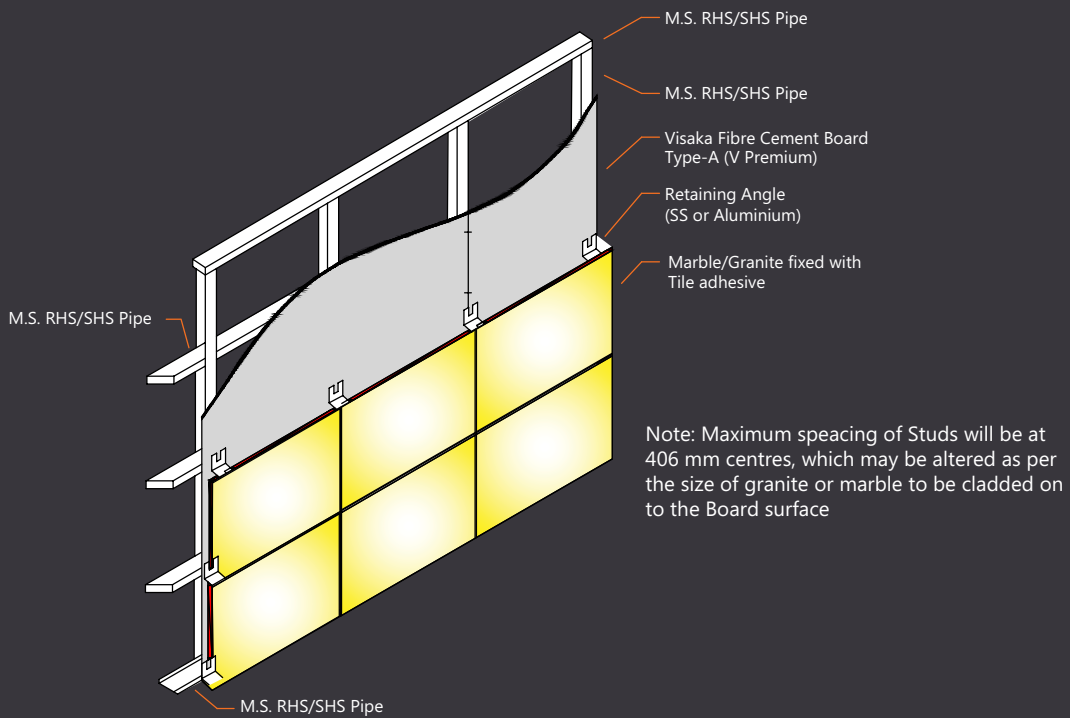
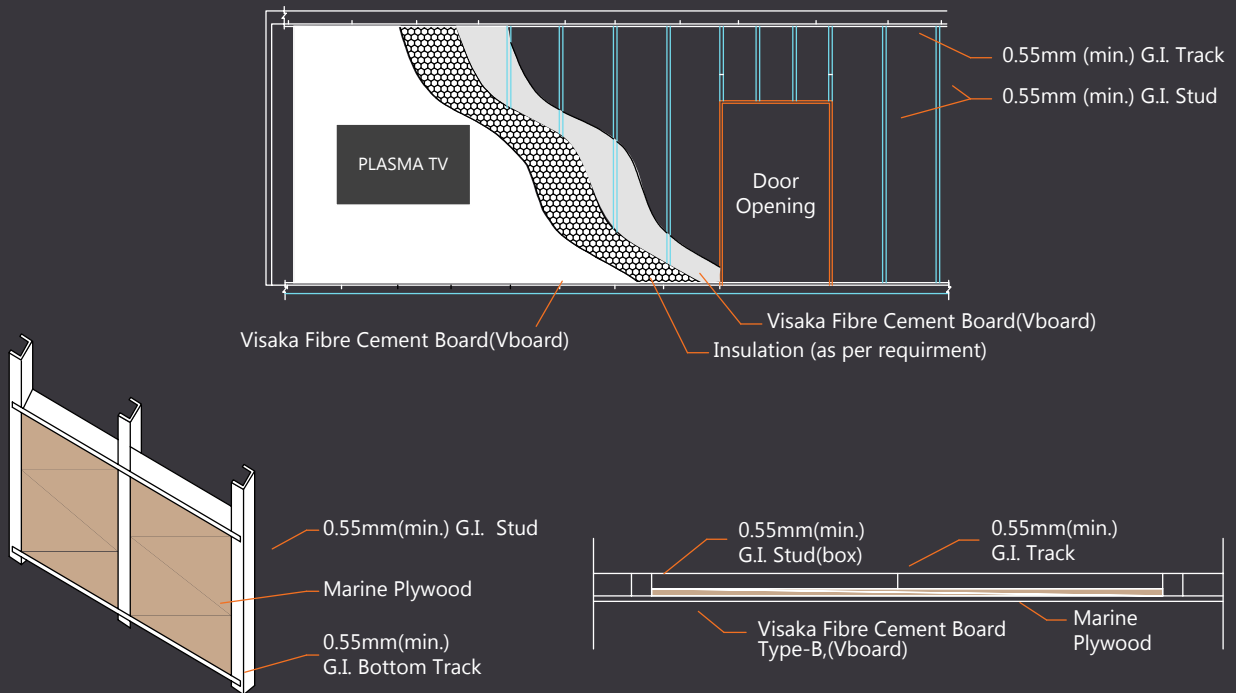

MECHANICAL CLADDING OF MARBLE / GRANITE ON VISAKA DRYWALL SYSTEMS

hand tools for professional work with Vboard



IMPACT DRILL
GSB 1300 PROFESSIONAL

Rated power input	550 W
No-load speed	0 - 2700 rpm
Weight without cable	1.8 kg
Weight without cable	1.7 kg
Drill spindle connecting thread	43
Chuck capacity	1,5 - 13 mm
Impact rate at no-load speed	0 - 41600 bpm
Drilling range	
Drilling dia. in concrete	13 mm
Drilling dia. in wood	25 mm
Drilling dia. in steel	10 mm
Drilling dia. in masonry	13 mm



ROTARY DRILL
GBM 13 RE PROFESSIONAL

Rated power input	600 W
No-load speed	0 - 2600 rpm
Power output	360 W
Weight without cable	1.7 kg
Torque (soft screwdriving applications)	0,0 / 1676,0 Nm
Rated torque	20,0 Nm
Drill spindle connecting thread	1/2" - 20UNF
Chuck capacity	1,5 - 13 mm
Drilling range	
Drilling dia. in aluminium	13 mm
Drilling dia. in wood	30 mm
Drilling dia. in steel	13 mm



DEPTH STOP SCREWDRIVER
GBH DRE PROFESSIONAL

Rated power input	701 W
Torque, max. (soft screwdriving applications)	20 Nm
Toolholder	1/4" internal hexagon
Power output	355 W
No-load speed	0 - 2500 rpm
Weight without cable	1.5 kg
Length	295 mm
Height	207 mm
Rated torque	2.3 Nm



MARBLE SAW
GDM 13-34 PROFESSIONAL

Rated power input	1,300 W
No-load speed	12000 rpm
Weight without cable	2.8 kg
Saw blade bore	20 mm
Saw blade diameter	110 mm
Cutting depth	
Cutting depth (90°)	34 mm
Cutting depth (45°)	22 mm

Visaka Industries Ltd. was promoted by Dr. G. Vivekanand in 1981 to manufacture fiber cement roofing sheets.

Today, we have manufacturing plants across the country with a turnover of ₹925 crores (USD 150 million), making us the second largest cement sheet manufacturer in India. The non-asbestos cement board & panel division was established in the year 2008. We possess a wide portfolio with 8 fiber cement roofing sheet plants having manufacturing capacity of 7,52,000 mt per annum, 2 Vboard plants having manufacturing capacities of 1,20,000 mt per annum, a Vpanel plant having manufacturing capacity of 3,00,000 sqm, and a textile yarn plant. With a focused vision of revolutionizing modern construction as we know it, we manufacture the highest quality products that are exported around the world and these products are well accepted in international and domestic markets alike.



visaka industries limited

Corporate Office :

Visaka Towers, 1-8-303/69/3,
S.P. Road, Secunderabad,
Andhra Pradesh, India - 500003
Tel: +91-40-2781 3833, 88867 86398.

Export email : export.vboard@visaka.in

Domestic email : domestic.vboard@visaka.in

Web: www.constructionnext.in

Factory 1

Gajalapuram Village,
Nalgonda District,
Andhra Pradesh, India.

Factory 2

Visaka Industries Limited
Gate no. 262 to 269
Delwadi Village, Daund taluq,
Pune, Maharashtra, India.

scan this image to
get in touch with us



DISCLAIMER :

All the sections, its dimensions and tools suggested in the technical handbook are indicative and suggestive only. The actual dimensions of members should be decided for all the applications by the end user in consultation with structural designer/structural engineer/consultant, taking in to consideration the local conditions of climate like wind, heat, snow, rain, & live loads. Visaka Industries Limited has no binding on the performance of the end product/application.